

GPX
OFFROAD
HORS ROUTE

LEATT®

GB -1 D -15 IT -19 FR -23 ES -27
BP -31 NL -35 SV -39 JP -43

READ BEFORE USE / LIRE AVANT UTILISATION



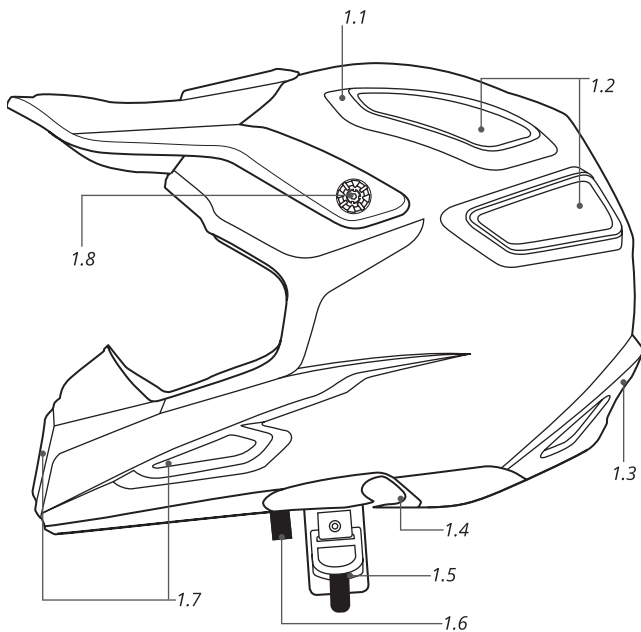


HEAD & BRAIN PROTECTION

PROTECTION TÊTE ET CERVEAU



Fig. 1



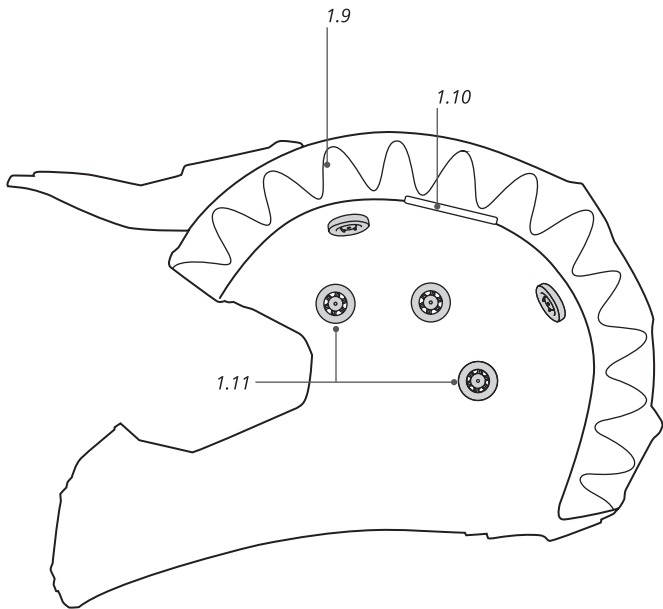




Fig. 2

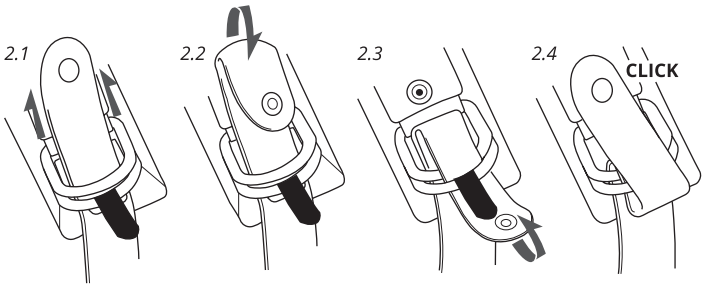


Fig. 3

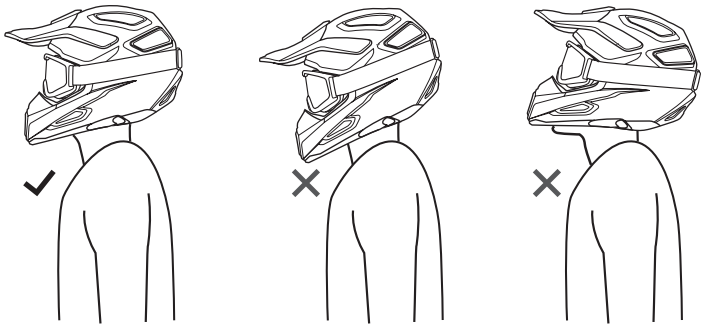


Fig. 4

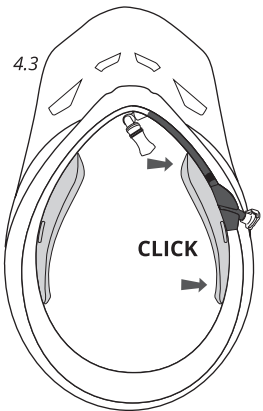
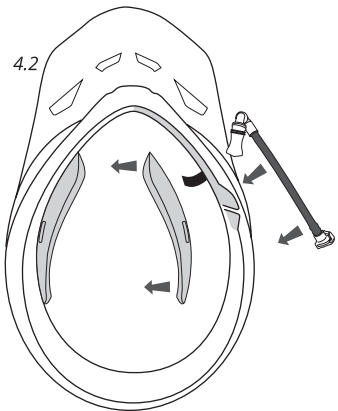
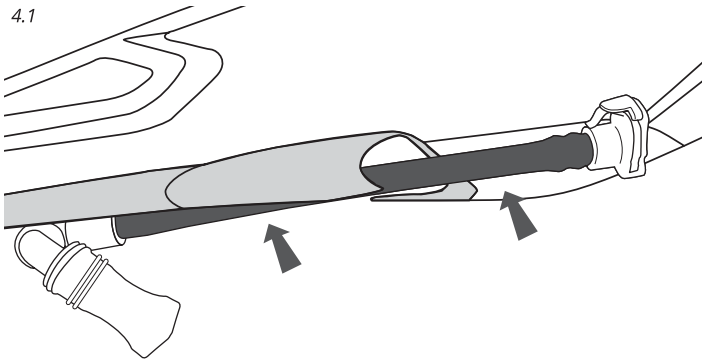




Fig. 5

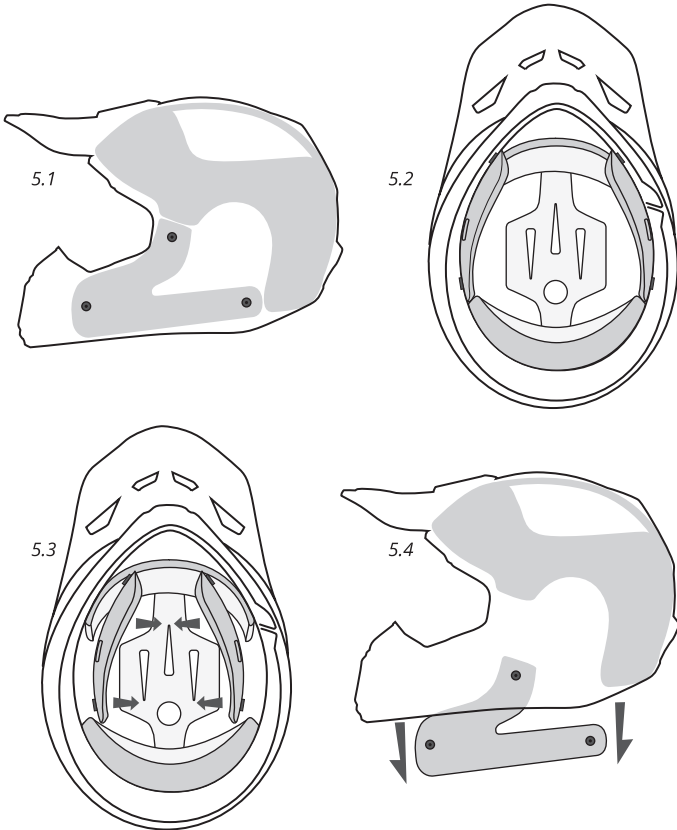




Fig. 6

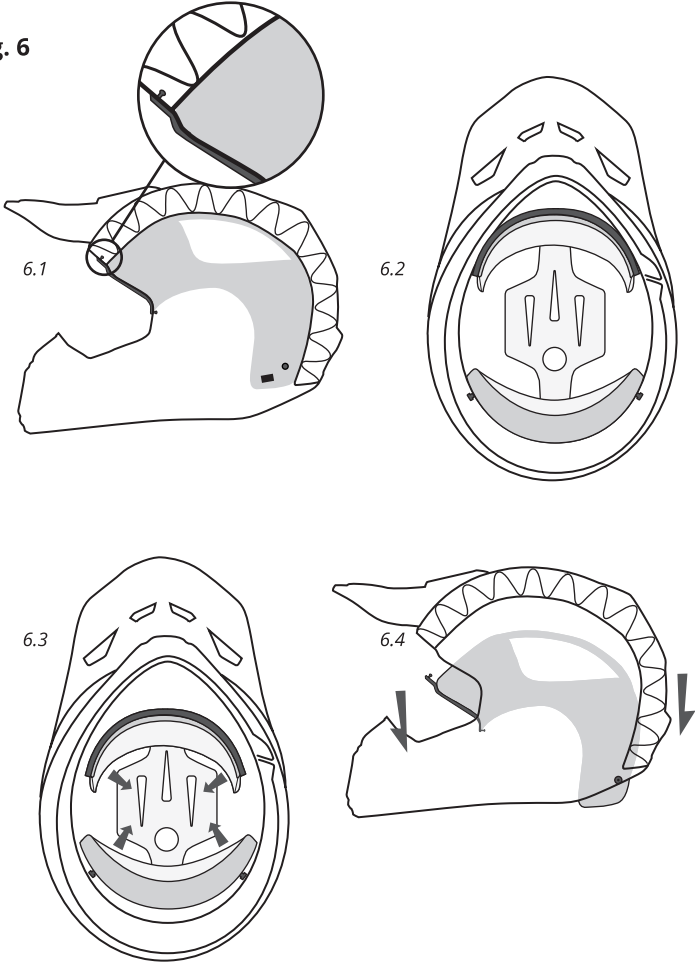
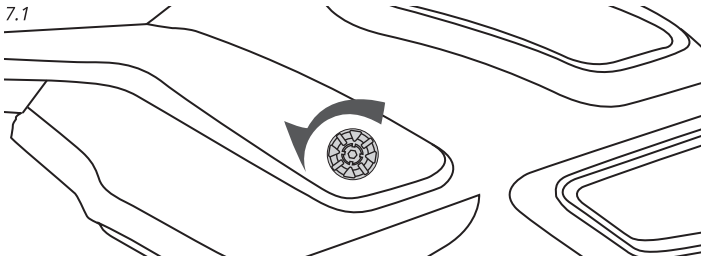


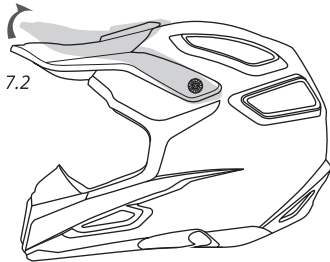


Fig. 7

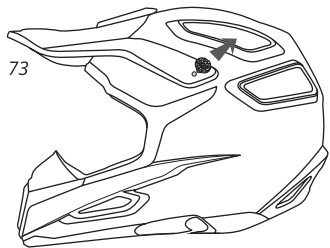
7.1



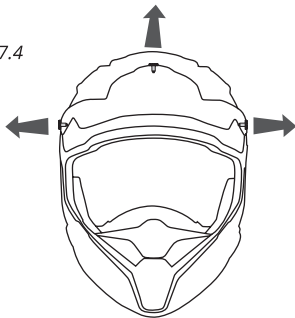
7.2



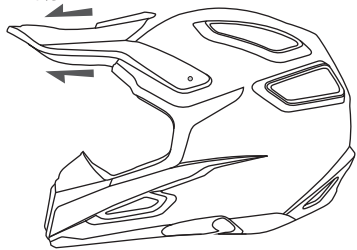
7.3



7.4



7.5



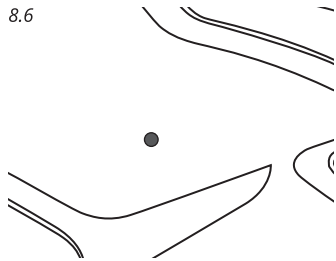
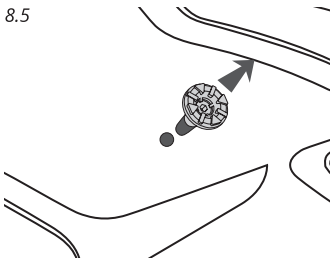
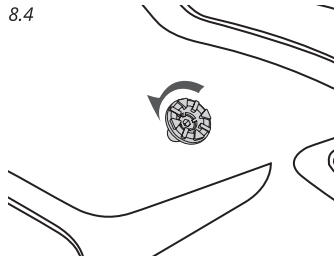
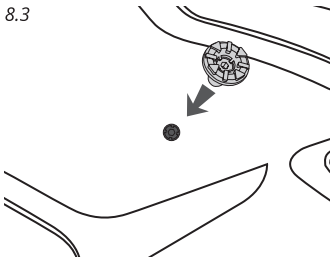
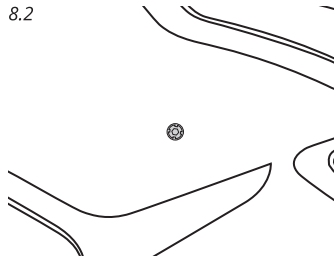
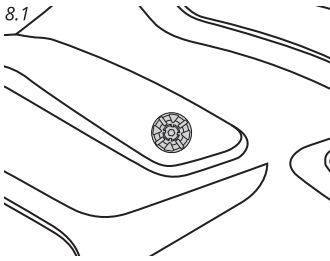
10

Copyright © 2016, Leatt® Corporation



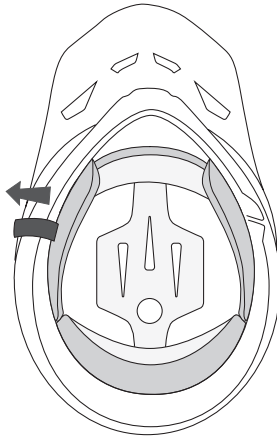


Fig. 8

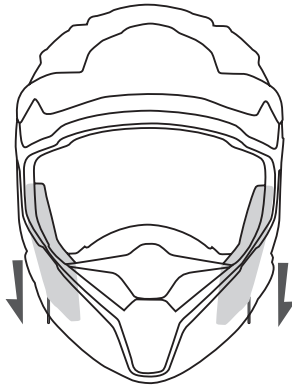




9.1



9.2



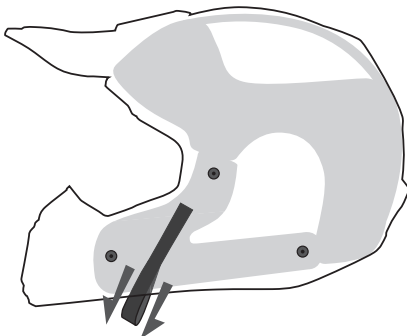
12

Copyright © 2016, Leatt® Corporation

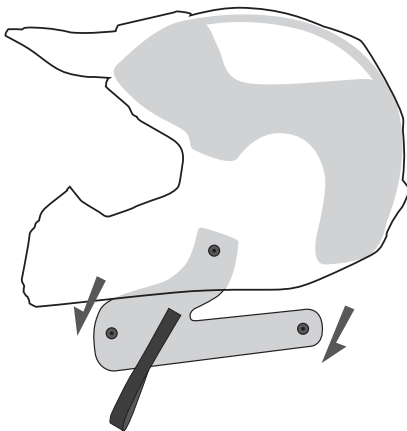




9.2



9.3





VARNING

HJÄLM UTVECKLAD OCH AVSEDD FÖR ATT ANVÄNDAS ENBART I MOTORSPORTER UTOM BIL. INGEN HJÄLM KAN SKYDDA MOT ALLA TYPER AV STÖTAR. ALLVARLIG SKADA ELLER DÖDSFALL KAN UPPSTÅ ÄVEN VID ANVÄNDANDE AV DENNA HJÄLM. FÖR ADEKVAT SKYDD, MÅSTE DENNA HJÄLM SITTA TÄTT OCH VARA SÄKERT FASTSPÄND. ALLA HJÄLMAR SOM VARIT MED OM NÅGON VÅLDSAM STÖT SKALL BYTAS UT. DENNA HJÄLMS SKYDDSFUNKTION KAN MINSKA AVSEVÄRT VID APPLICERING AV FÄRG, KLISTERMÄRKEN ELLER DEKALER, RENGÖRINGSVÄSTSKOR ELLER ANDRA LÖSNINGSMEDEL. SKAL TILLVERKAT AV KOLFIBER . ARAMID, GLASFIBER MED EPOXI HARTS ELLER POLYKARBONAT/ABS TERMOPLAST. INSIDA TILLVERKAD AV EXPANDERAD POLYSTYREN. ANVÄND ENBART MATERIAL SOM REKOMMENDERAS AV HJÄLMTILLVERKAREN. LÄS OCH FÖLJ ALLA INSTRUKTIONER I ANVÄNDARMANUALEN.



INSTRUKTIONER



Gör inga modifieringar på hjälmen, inklusive ytterskalet, innerfodret i EPS eller hakremmen. Eventuell/a modifieringar ogiltigförklarar alla garantier och påverkar hjälmens prestanda.

Hjälmen passar att användas tillsammans med glasögon.

Fodret är ytterst viktigt för hjälmens avsedda prestanda.

Hjälmen har en begränsad livslängd vid användning och skall bytas ut när den uppvisar tydliga tecken på slitage, t.ex. förändrad passform, sprickor, rost eller nötning.

Leatt® GPX-hjälm utgör en del av det skyddsutrustningsutbud som finns tillgängligt för utövare av sportaktiviteter för motorcykel. Försiktighet ska alltid vidtas vid utövande av motorsportaktiviteter och lämplig säkerhetsutrustning ska användas.

Fig.1 (p.4-5) - Tekniska funktioner

- 1.1. 3D-förstärkt struktur
- 1.2. Andnings- ventilation
- 1.3. LEATT-STÖD® Kompatibel
- 1.4. LEATT® Hydrering Kompatibel
- 1.5. Hakrem
- 1.6. Emergency Release
- 1.7. Andnings-intag
- 1.8. Skärm med brake away-funktion
- 1.9. Ingjuten Multidensitet V-skum
- 1.10. Utstötningssystem Kompatibel
- 1.11. 360° Turbinteknik

Fig.2 (p.6) - Knäppning av hakremmen

Fig.3 (p.6) - Korrekt passform

Fig.4 (p.7) - Införing av LEATT® hydrerings-kit

Fig.5 (p.8) - Borttagning av kindkuddar

Fig.6 (p.9) - Borttagning av komfortfoder

Fig.7 (p.10) - Justering och borttagning av visir (skärm)

Fig.8 (p.11) - Borttagning av söndrig skärm med brake away-funktion

Fig.9 (p.12-13) - Emergency Release-kindkuddar

Rengöring



Torka enbart rent



Droptorka i skugga



Stryk inte



Maskintvätta inte



Blek inte



Torktumla inte

Rengör enbart med en mjuk trasa som fuktats med mild tvål eller milt rengöringsmedel i kallt vatten. Skölj genom att torka av med en mjuk trasa som fuktats med kallt vatten och torka med en torr trasa. Komfortkuddar kan handtvättas och lufttorkas.

Vanliga medel som appliceras på denna produkt (lösningsmedel, rengöringsmedel, hårvatten etc.) kan orsaka skada som inte syns men som kan orsaka sämre effekt/säkerhet hos din Leatt®-hjälm. Kontrollera alltid materialinnehållet på etiketten i din hjälm. Inget av de material som använts för att tillverka denna produkt är känt för att innehålla något ämne som kan orsaka allergiska reaktioner eller vara farliga för hälsan.

GARANTI

Din Leatt®-produkt är garanterad för material- och tillverkningsfel under ett år från inköpsdatum. Din Leatt®-produkt kan gå sönder under vissa användningsförhållanden. Skador som orsakats av olyckor, fall, våld eller felaktig användning täcks därför inte av denna begränsade garanti.

Gå till www.leatt.com eller skicka e-post till warranty@leatt.com om du vill göra garantianspråk.

LEATT® CORPORATION FRÅNSÄGER SIG ALLA ÖVRIGA GARANTIER, UTTRYCKLIGA ELLER UNDERFÖRSTÅDDA, INKLUSIVE SÄLJBARHET FÖR ETT SÄRSKILT SYFTE.



SV

Kontaktuppgifter

Huvudkontor:

Nr 12, Kiepersol Crescent, Atlas Gardens,
Contermanskloof, Durbanville, 7550,
Cape Town, Sydafrika
Tel: +27 21 557 7257
Fax: +27 21 557 7381
E-post: info@leatt.com
Webbplats: www.leatt.com

Postadress:

Suite 109, Private Bag X3, Bloubergrant,
7443, Sydafrika

USA:

Tel: 661 287 9258
Avgiftsfritt: 1.800.691.3314
Fax: 661 287 9688

Europa:

E-post: Leatt-EU-contact@leatt.com

LEATT® Features

- ! 360° Turbine Technology
 - Reduces up to 30% of head impact at concussion level
 - Reduces up to 40% of rotational acceleration to head and brain
 - Improves multiple-impact protection
 - Turbines are made of 3D molded Armourgel® that helps absorb impact forces
- ! Reduced Outer Shell Volume
- ! 3D In-Molded V-Foam
- ! Optimal Neck Brace Compatibility
- ! Quattro Force Control
- ! Maximized Ventilation – effective even at very low speeds
- ! Visor with breakaway function for rotational reduction in a crash
- ! Low friction cheek pads for emergency removal
- ! Hydration ready (with optional hands-free kit)
- ! Moisture-wicking, breathable, anti-odor and washable liner (using zinc pyrithion)
- ! Certified and tested
- ! Lightweight and premium protection
- ! Adult XS to XXL

www.leatt.com   

BARCODE

Made in China.